

# SECTION 4 CONTROLS

|   |              |
|---|--------------|
| <b>Steering</b>                                 | <b>4.1</b>   |
| Steering Control System Illustrations . . . . . | pg. 4-2, 4-3 |
| Neutral Adjustment . . . . .                    | pg. 4-4, 4-6 |
| Tracking Adjustment (Speed) . . . . .           | pg. 4-7      |
| Control Lever Replacement . . . . .             | pg. 4-8      |
| <b>Foot Pedals</b>                              | <b>4.2</b>   |
| Foot Pedal System Illustration . . . . .        | pg. 4-9      |
| Angle Adjustment . . . . .                      | pg. 4-10     |
| Pedal Replacement . . . . .                     | pg. 4-11     |
| <b>Hand Controls</b>                            | <b>4.3</b>   |
| Hand Control System Illustration . . . . .      | pg. 4-12     |
| Cable Replacement . . . . .                     | pg. 4-13     |
| Angle Adjustment . . . . .                      | pg. 4-14     |
| Control Lever Replacement . . . . .             | pg. 4-15     |
| <b>Throttle</b>                                 | <b>4.4</b>   |
| Throttle System Illustration . . . . .          | pg. 4-16     |
| Adjustment . . . . .                            | pg. 4-17     |
| Throttle Rod Replacement . . . . .              | pg. 4-18     |
| <b>Restraint Bar</b>                            | <b>4.5</b>   |
| Restraint Bar System Illustration . . . . .     | pg. 4-19     |
| Gas Spring Replacement . . . . .                | pg. 4-20     |
| Restraint Bar Replacement . . . . .             | pg. 4-21     |
| <b>Parking Brake</b>                            | <b>4.6</b>   |
| General Information . . . . .                   | pg. 4-22     |
| <b>Trouble Shooting</b>                         | <b>4.7</b>   |
| Steering Controls . . . . .                     | pg. 4-23     |
| Foot Pedals . . . . .                           | pg. 4-23     |
| Hand Controls . . . . .                         | pg. 4-23     |
| Restraint Bar . . . . .                         | pg. 4-23     |



# STEERING 4.1

4

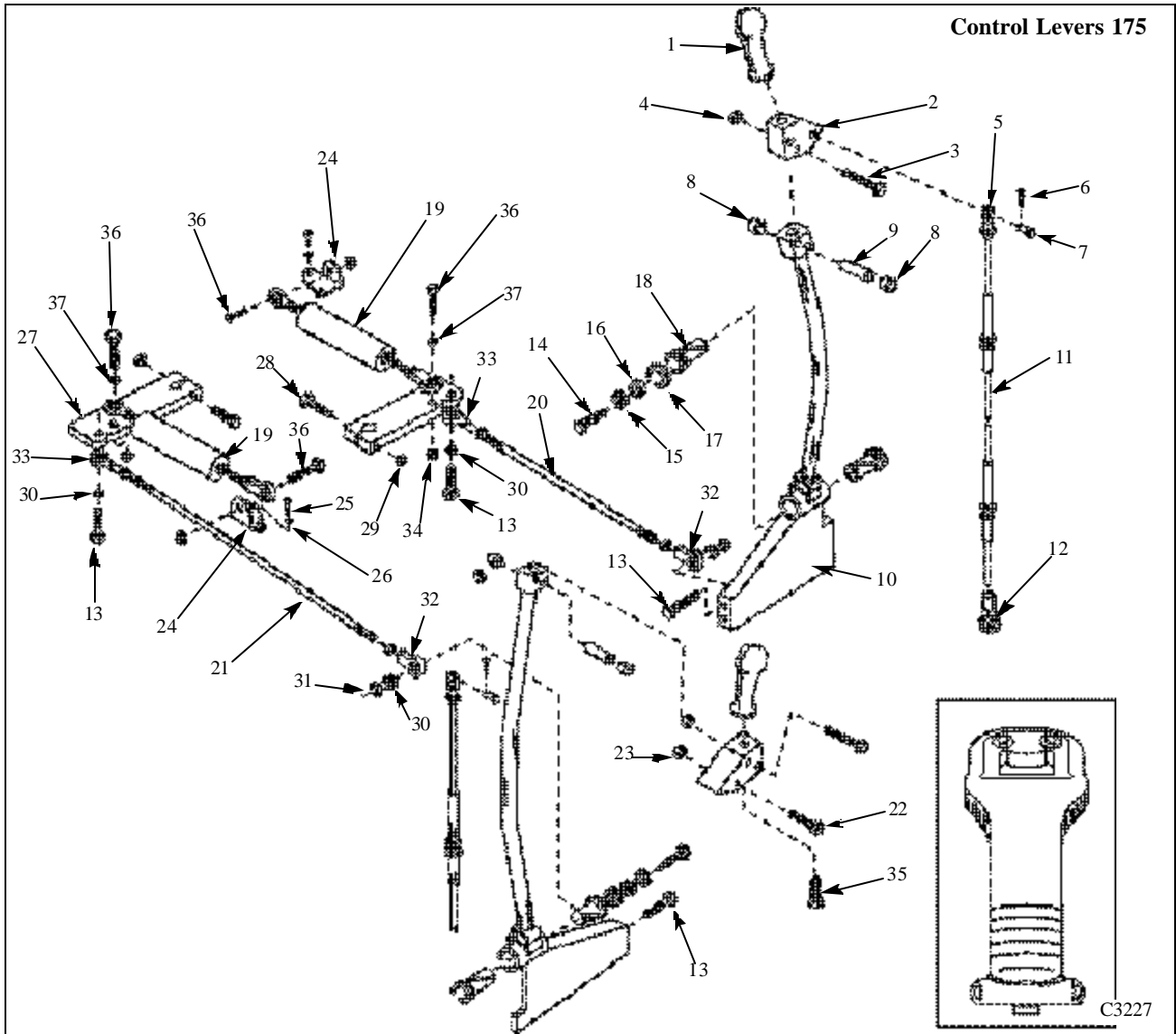

- |    |   |    |                          |    |                                  |
|----|---|----|--------------------------|----|----------------------------------|
| 1  | Handle, Ergonomic Plain                 | 15 | Washer, Lock             | 32 | Rod End Ass'y, Female            |
| 2  | Handle, Ergonomic w/Rocker Switch       | 16 | Washer, Flat             | 33 | Rod End Ass'y, Female            |
| 3  | Bolt, Hex.                              | 17 | Washer, Fender           | 34 | Nut, Nylok                       |
| 4  | Jam Nut, Locking                        | 18 | Flange Bushing           | 35 | Bolt, Ergonomic Handle (w/Hole)  |
| 5  | Clevis (Hand Control Loaders)           | 19 | Hydroback Ass'y          | 36 | Bolt, Ergonomic Handle (No Hole) |
| 6  | Cotter Pin (Hand Control Loaders)       | 20 | Bar, Pintle Linkage L.H. | 37 | Washer                           |
| 7  | Clevis Pin (Hand Control Loaders)       | 21 | Bar, Pintle Linkage R.H. |    |                                  |
| 8  | Flange Bushing                          | 22 | Bolt, Hex                |    |                                  |
| 9  | Tube, Handle Spacer                     | 23 | Hex Nut, Nylok           |    |                                  |
| 10 | Control Lever, L.H.                     | 24 | Hydroback Mount          |    |                                  |
|    | Control Lever, R.H.                     | 25 | Bolt                     |    |                                  |
| 11 | Cable, Push-Pull (Hand control Loaders) | 26 | Washer                   |    |                                  |
| 12 | Rod End Ass'y (Hand Control Loaders)    | 27 | Pintle Lever Ass'y       |    |                                  |
| 13 | Bolt, Hex                               | 28 | Bolt                     |    |                                  |
| 14 | Bolt                                    | 29 | Nut                      |    |                                  |
|    |   | 30 | Washer, Lock             |    |                                  |
|    |   | 31 | Nut, Nylok               |    |                                  |

# STEERING 4.1

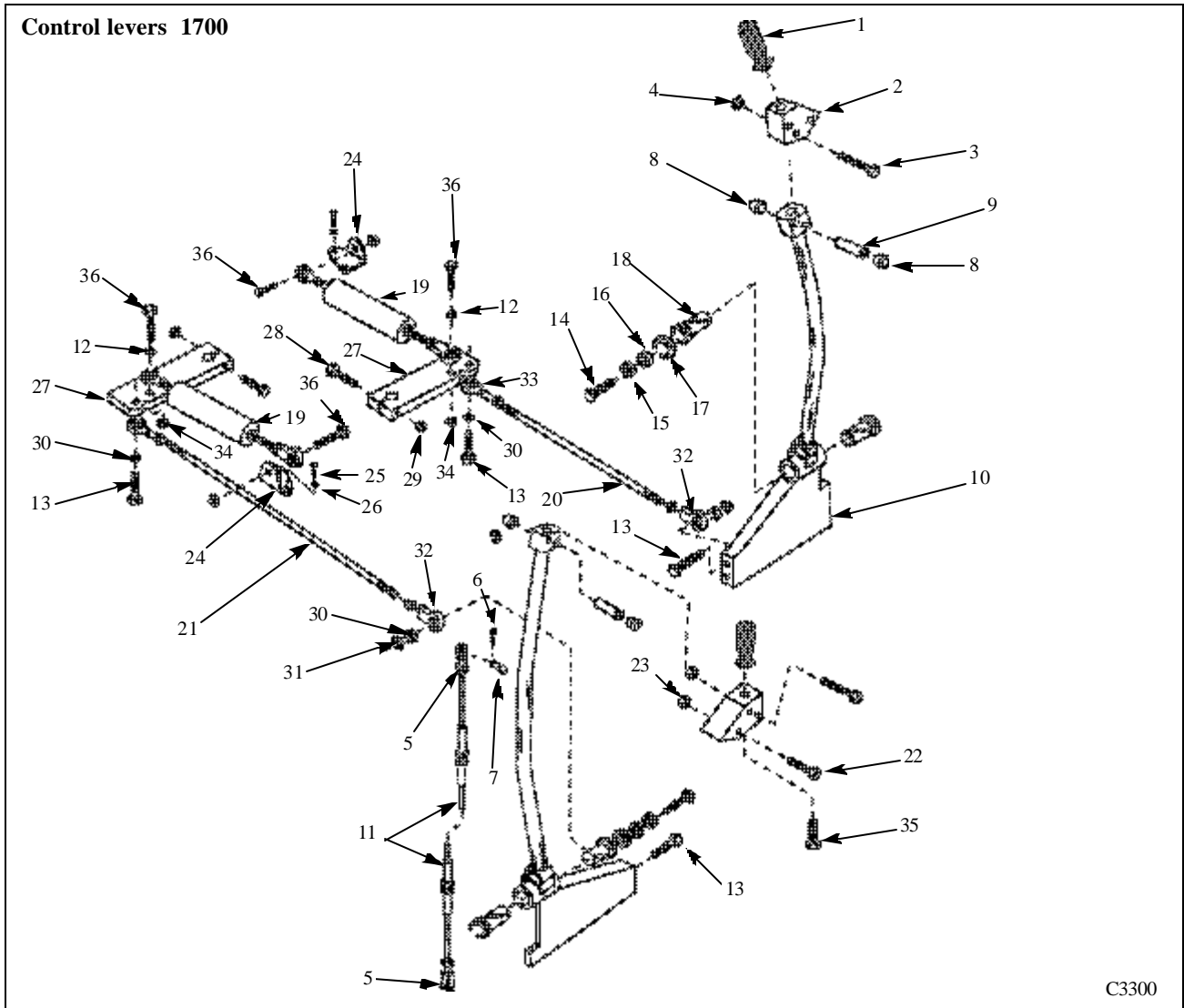

- |    |  |    |                          |    |                       |
|----|--|----|--------------------------|----|-----------------------|
| 1  | Handle, Control                            | 15 | Washer, Lock             | 32 | Rod End Ass'y, Female |
| 2  | Lever Base Welded Ass'y                    | 16 | Washer, Flat             | 33 | Rod End Ass'y, Female |
| 3  | Bolt, Hex.                                 | 17 | Washer, Fender           | 34 | Nut, Nylok            |
| 4  | Jam Nut, Locking                           | 18 | Flange Bushing           | 35 | Bolt, Hex             |
| 5  | Clevis                                     | 19 | Hydroback Ass'y          | 36 | Washer                |
| 6  | Cotter Pin                                 | 20 | Bar, Pintle Linkage L.H. |    |                       |
| 7  | Clevis Pin                                 | 21 | Bar, Pintle Linkage R.H. |    |                       |
| 8  | Flange Bushing                             | 22 | Bolt, Hex                |    |                       |
| 9  | Tube, Handle Spacer                        | 23 | Hex Nut, Nylok           |    |                       |
| 10 | Control Lever, L.H.<br>Control Lever, R.H. | 24 | Hydroback Mount          |    |                       |
| 11 | Cable, Push-Pull                           | 25 | Bolt                     |    |                       |
| 12 | Washer                                     | 26 | Washer                   |    |                       |
| 13 | Bolt, Hex                                  | 27 | Pintle Lever Ass'y       |    |                       |
| 14 | Bolt                                       | 28 | Bolt                     |    |                       |
|    |  | 29 | Nut                      |    |                       |
|    |  | 30 | Washer, Lock             |    |                       |
|    |  | 31 | Nut, Nylok               |    |                       |

# STEERING 4.1

## Neutral Adjustment

### IMPORTANT

If you are unfamiliar with the control operations of the loader, read the Owner's / Operator's Manual beforehand.

The steering levers are equipped with a spring centering device called a hydroback. The hydroback returns the steering lever to neutral position when the steering levers are not being operated.

This feature automatically keeps the loader in neutral whenever the engine is started, or when the control levers are released.

If the loader creeps, or is not in neutral, when the engine is started or the steering lever is released from forward or reverse position, the hydroback device may need to be adjusted, repaired or replaced.

1 Raise the boom arms, engage the boom support pins and shut off the engine. Raise and block the loader securely off the ground.

2 Remove the seat and hydrostatic shield.(fig. C3557)  
Note the location of the hydroback. (fig. C3556)

3 Cycle the control lever while watching the hydroback action. The hydroback should return the lever to a neutral position.

4 Check the rod ends on each end of the hydroback. They must be free of any play. Replace the rod ends if any play or slack is noticed. (fig. C3555)

5 If the control lever is able to move slightly without spring tension returning it to neutral, the hydroback needs adjusted.



### WARNING

Never work under the boom arms without the boom supports engaged.

### IMPORTANT

Repairs or adjustment to the control lever system may change the loader neutral position. Make sure the loader is raised securely off the ground before restarting the engine.

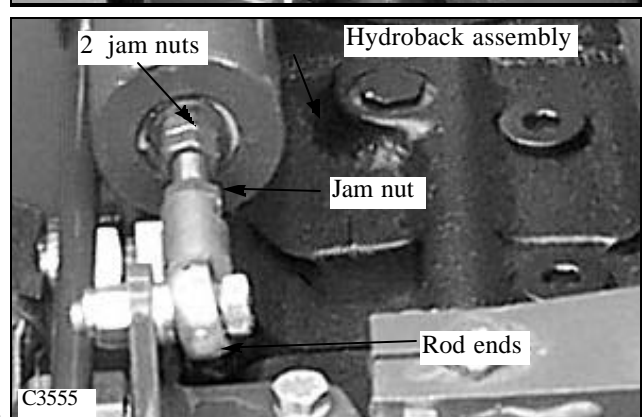
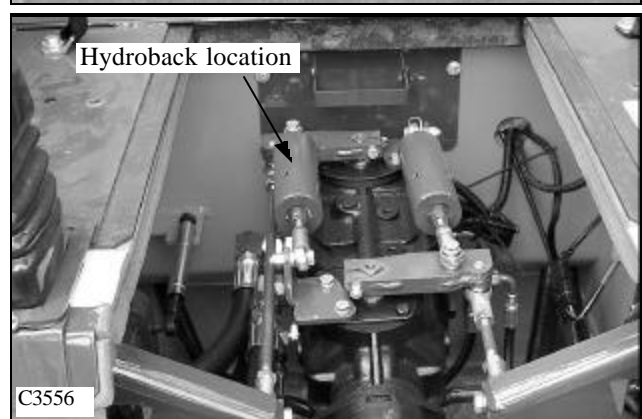
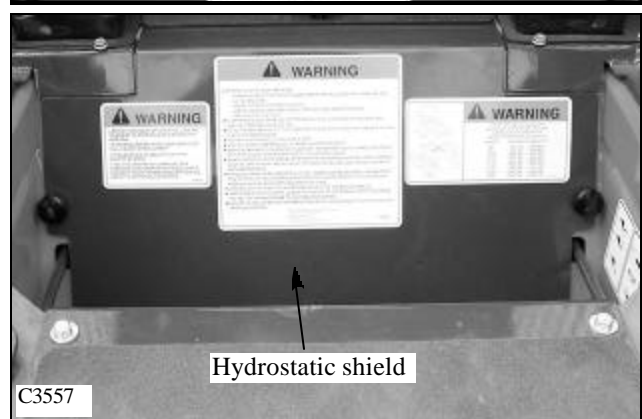

# STEERING 4.1

## Neutral Adjustment (con't.)

- 6 Loosen the 2 jam nuts next to the main body. (fig. C3555)
- 7 Turn the 2 nuts away from the main body of the hydroback.
- 8 Cycle the control lever several times.
- 9 Push the control lever rearward until you feel resistance. Stop.
- 10 Turn the 2 jam nuts back toward the main body of the hydroback until the nut just touches the flat washer.
- 11 Cycle the control lever again checking for a neutral position. If the lever returns to neutral, tighten the 2 jam nuts together. If the hydroback still does not center, the hydroback has internal damage or wear. Replace the hydroback assembly with a new one.

### IMPORTANT

Repairs or adjustment to the control lever system may change the loader neutral position. Make sure the loader is raised securely off the ground before restarting the engine.

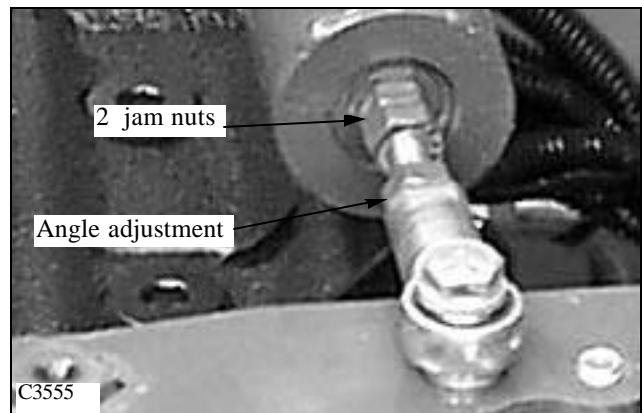
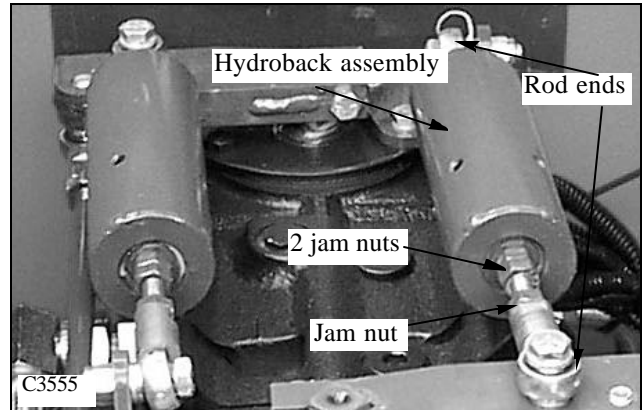

## Hydro Back Replacement

Replacing the hydro back changes the steering control lever angle. To correctly set the angle after the hydro back has been installed:

- 1 Replace the hydro back by removing the 2 bolts located at either end of the hydro back assembly.
- 2 Install the hydro back in the reverse order. Check the steering control rod ends and replace them now if they are worn.
- 3 Use an angle finder to check the base measurement angle the loader is sitting at. (fig. C3552) Note the angle the loader is sitting at. This measurement will have to be added or subtracted to the next measurement to give the most accurate adjustment.
- 4 Attach an angle finder to the most vertical part of the control lever. (fig. C3553)
- 5 Turn the hydro back threaded rod (fig. C3555) in or out of the female rod end to move the control lever to a reading of 0°. Be sure to allow for angle the loader is sitting at. (Base angle) Jam the nut against the rod end when completed.

Make sure there is a minimum of 3/8" (6mm) of thread holding the female rod end to the threaded rod.

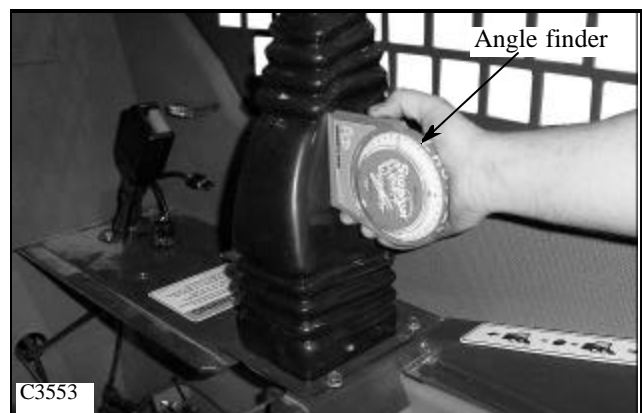

# STEERING 4.1

## Neutral Adjustment

Before performing the neutral adjustment make sure the hydro back is functioning and adjusted properly. Refer to page 4-4.

### IMPORTANT

If you are unfamiliar with the control operations of the loader, read the Owner's / Operator's Manual beforehand.

1 Raise the boom arms, engage the boom support pins and shut off the engine. Raise and block the loader securely off the ground.



### WARNING

Never work under the boom arms without the boom supports engaged.

2 Remove the seat and hydrostatic shield. Note the location of the steering control linkage. (fig. C3554)

3 Check the control rod end bushings for wear. If any play is present between the bushings and the bolts replace the rod ends.

4 Check the pintle lever for tightness on the swash plate shaft. Tighten the clamping bolt or replace the pintle lever if required. (fig. C3558)

5 If and when all rod bushings and pivot points have been checked for wear or binding, proceed with the neutral adjustment.

6 Loosen the jam nuts on the control rod linkage. (fig. C3554) One end of the control rod is R.H. threads, the opposite end has L.H. threads.

7 Start the engine and release the parking brake.

8 Turn the control rod linkage and visually watch the wheels as they turn. Stop turning the control rod linkage when the wheels are in neutral. Tighten the jam nuts against the rod ends and recheck the neutral adjustment.

9 Very fine adjustment can be made at the hydro back threaded rod. Adjustment here affects the control lever angle. **Only make minor adjustments using this method.**

10 Replace the seat and hydrostatic shield.

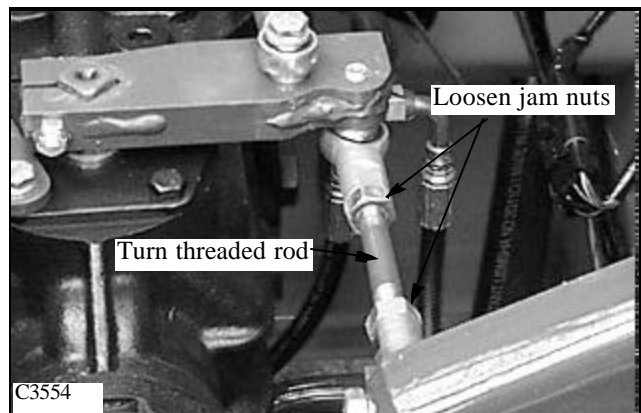
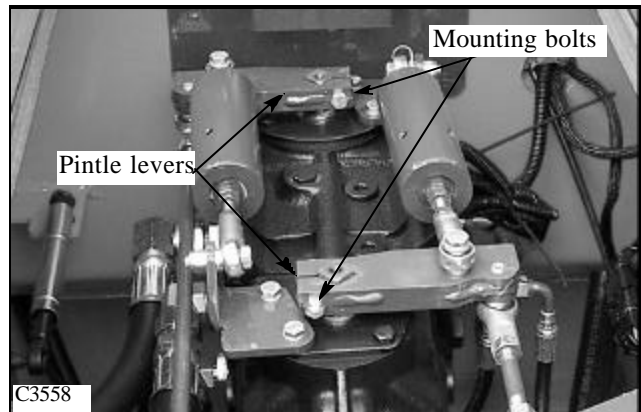
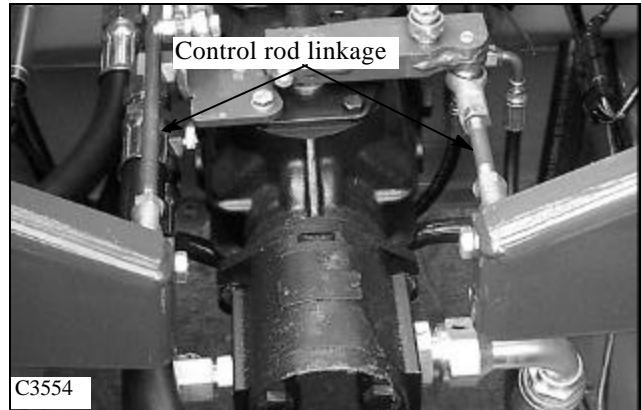

### WARNING

Repairs or adjustment to the control lever system may change the loader neutral position. Make sure the loader is raised securely off the ground before restarting the engine.

4

# STEERING 4.1

## Tracking Adjustment (Speed)

Tracking adjustment, or wheel speed, is set individually for L.H. and R.H. sides. If the operator complains the loader does not go in a straight line when the levers are pushed clear forward the limiter stops may need adjustment.

1 Raise the boom arms, engage the boom support pins and shut off the engine. Raise and block the loader securely off the ground.



### WARNING

**Never work under the boom arms without the boom supports engaged.**

2 Remove the seat and hydrostatic shield. Note the location of the steering control limiter bolts located front and rear of each steering control lever, just below the pivot point.. (fig. C3559)

3 Make sure the neutral adjustments are adjusted correctly. Refer to pages 4- 4 ~ 4-6.

4 If and when all rod bushings and pivot points have been check for wear or binding, proceed with the wheel speed adjustment.

5 Start the engine and release the parking brake. Adjust the engine RPM to the full high idle position. Refer to Section 7 to verify engine RPM.



### WARNING

**Raise the loader securely off the ground before starting the engine.**

6 Using an RPM surface speed measuring tool (Thomas P/N 43981) check each wheel speed in the forward and reverse direction. Repeat for opposite side. (fig. C3560)

7 Correct wheel speed is set evenly at 83 RPM forward and reverse for both sides.

8 If adjustment is necessary, loosen the jam nut (fig. C3559) and turn the limiter bolt in to increase wheel speed or out to slow it down.

9 Tighten the jam nut and retest the speed adjustment. Repeat if necessary.

10 Replace the seat and hydrostatic shield.

**Note:** If the wheel speed does not meet the above specification, check the engine RPM. Refer to Section 7.

If the engine RPM checks out good you may need to check for hydrostatic problems such as drive motor seal leakage etc. Refer to Section 2 for testing procedures.

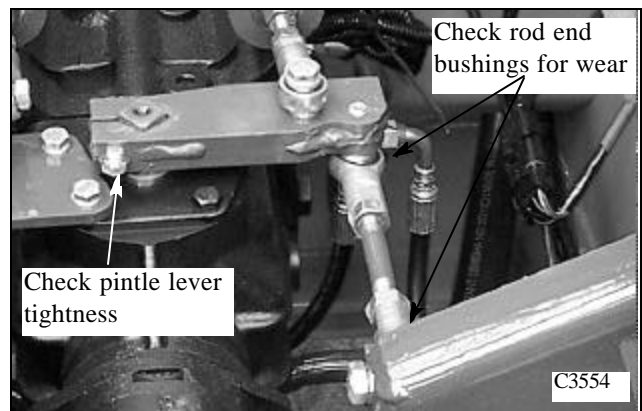
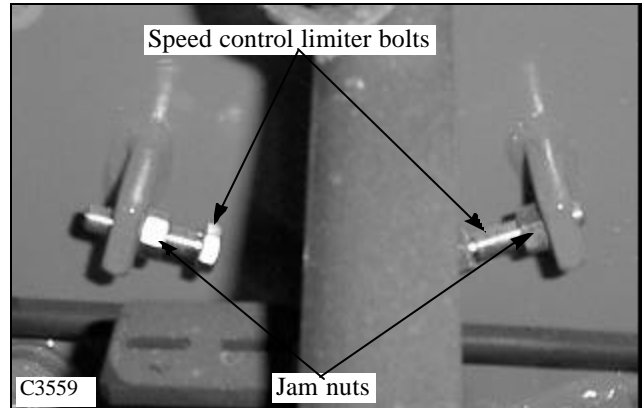

4

# STEERING 4.1

## Control Lever Replacement

1 Raise the boom arms, engage the boom supports and shut off the engine. Raise the loader securely off the ground to prevent accidental engagement of the drive functions upon restarting the engine.



### WARNING

**Never work under the boom arms without the boom supports engaged.**

- 2 Remove the seat and hydrostatic shield.
- 3 Remove the two bolts from the lever base.
- 4 Remove the control handle by turning counter clockwise.
- 5 Remove the screws holding the bellows cover down. (fig. C3561)
- 6 Remove the bolt going through the control rod and hydro back linkage. (fig. C3562)
- 7 Remove the bolt and washers mounting the control lever to its pivot point. (fig.C3559) The control lever is now free to be removed.
- 8 Replace the control lever in the reverse order. Lightly lubricate the pivot shaft with white grease when assembling the control lever to the pivot shaft.
- 9 If necessary, make adjustments to the neutral centering and wheel speed as required. Refer to pages 4 - 4 ~ 4 - 7.

**Note:** If the loader is equipped with optional electrical accessories operated by control handle mounted switches, the control handle switch wiring will need to be disconnected and transferred to the new steering lever.



### WARNING

**Repairs or adjustment to the control lever system may change the loader neutral position. Make sure the loader is raised securely off the ground before restarting the engine.**

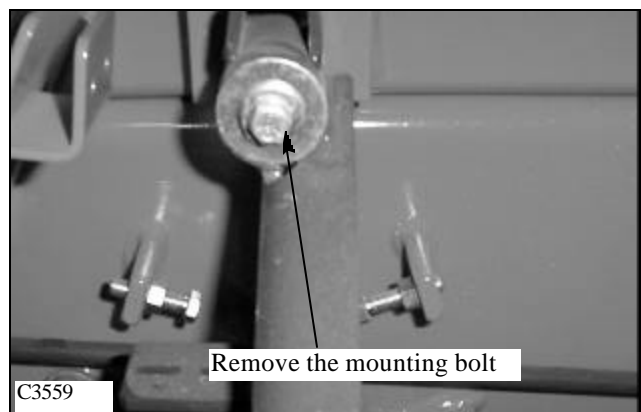
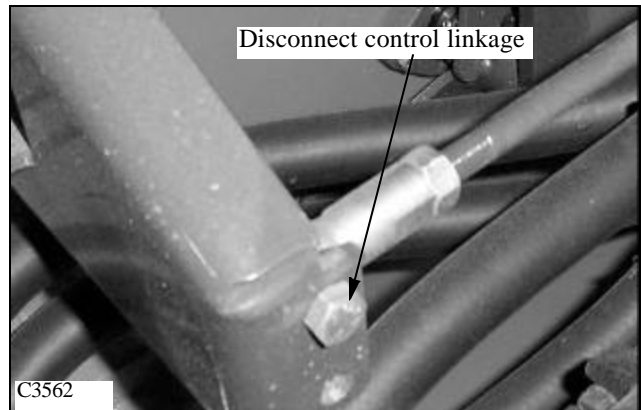
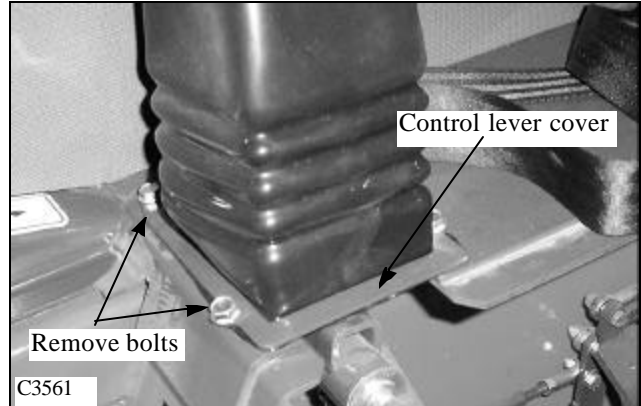

4



# FOOT PEDALS 4.2

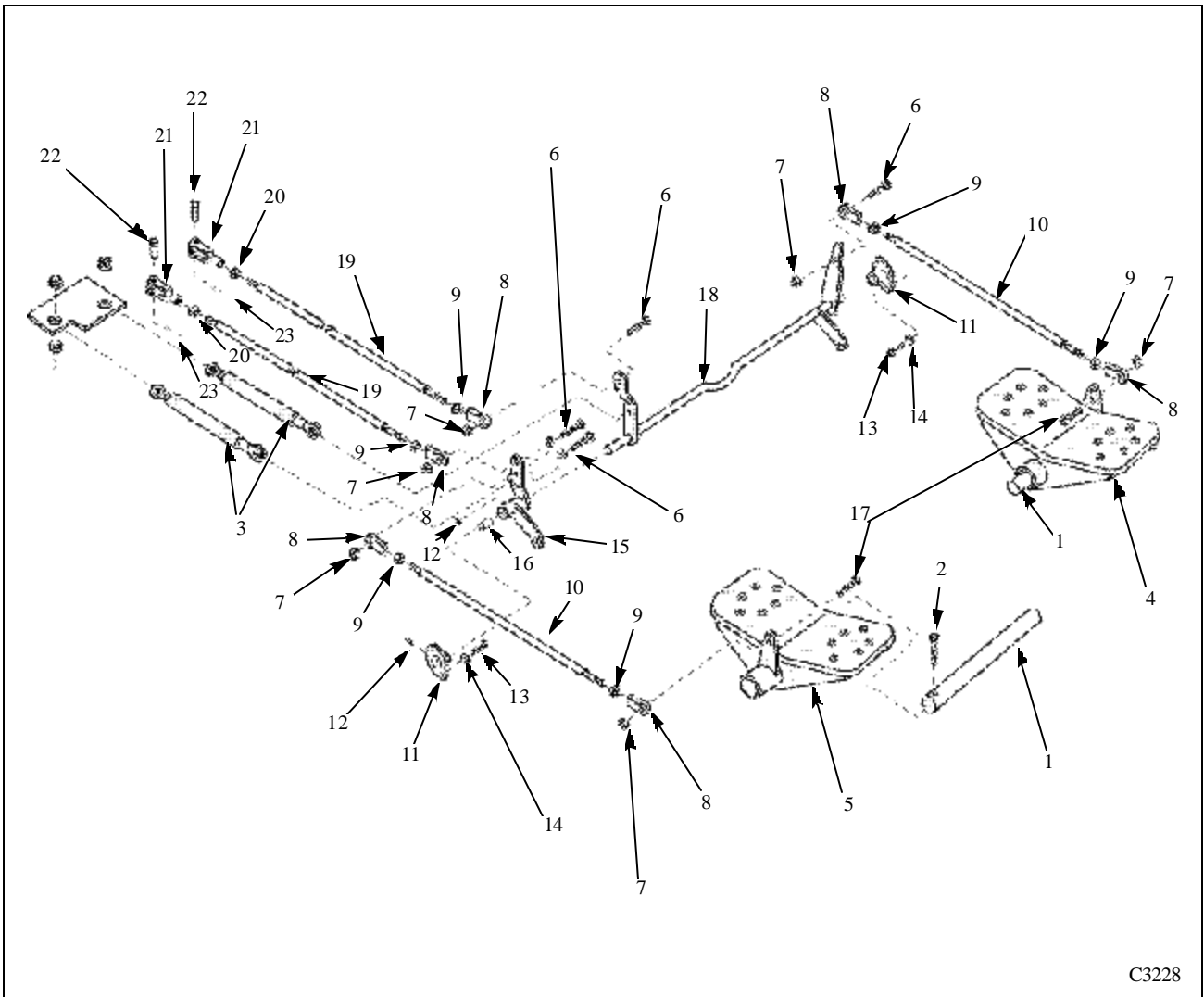

C3228

- |   |                               |
|---|-------------------------------|
| 1. Bar, Foot Pedal Shaft                  | 13. Bolt, Hex                 |
| 2. Screw, Cap, Hex Socket head, Stainless | 14. Washer, Lock              |
| 3. Dampener, Self-Centering, 9 lbs.       | 15. Activator, R.H. Ass'y     |
| 4. Pedal, Lift Ass'y (L.H.)               | 16. Bearing                   |
| 5. Pedal, Lift Ass'y (R.H.)               | 17. Bolt, Carriage            |
| 6. Bolt, Hex                              | 18. Control Cross Shaft Ass'y |
| 7. Nut, Nylok, Hex                        | 19. Bar, Valve Control, Rear  |
| 8. Rod End Ass'y                          | 20. Nut, Hex                  |
| 9. Nut, Hex                               | 21. Clevis                    |
| 10. Bar, Valve Control Front              | 22. Clevis Pin                |
| 11. Bearing, Flanged, 2-Bolt              | 23. Cotter Pin                |
| 12. Grease Fitting                        |                               |



# FOOT PEDALS 4.2

## Angle Adjustment

The foot pedal angle can be verified and / or adjusted to provide operator comfort and proper pedal travel clearance.

**Note:** If the operator feels discomfort due to current pedal angles, they may be adjusted to their preference. Be sure to check for pedal travel clearance afterward. Always maintain a minimum of 3/8" (6mm) of thread into the cable clevis and eyelet cable ends. (fig. C3563)

- 1 Make sure the cable ends are screwed onto the cable threads a minimum of 3/8" (6mm). (fig. C3563)
- 2 Place an angle finder on the inner ROPS frame bottom of the loader to find the base measurement. Note the reading. (fig. C3564)

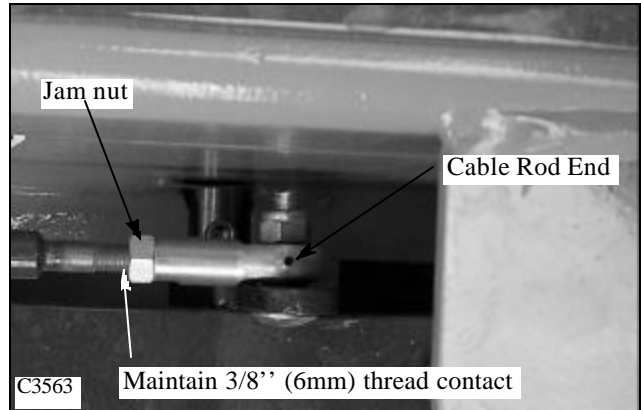

4

- 3 Place the angle finder on the heel of the pedal to be checked or adjusted. (fig. C3565) Note the reading.

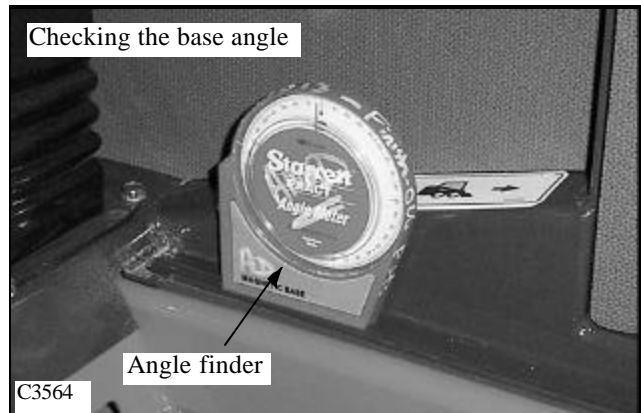

- 4 Adjust the pedal angles by turning the rod ends on the end of the linkage attached to the pedals. Adjust the lift and tilt pedal angle to 20°. Be sure to allow for the base angle measurement taken previously. Example: If the base angle measured 3°, add or subtract that angle from the angle measured on the pedal.

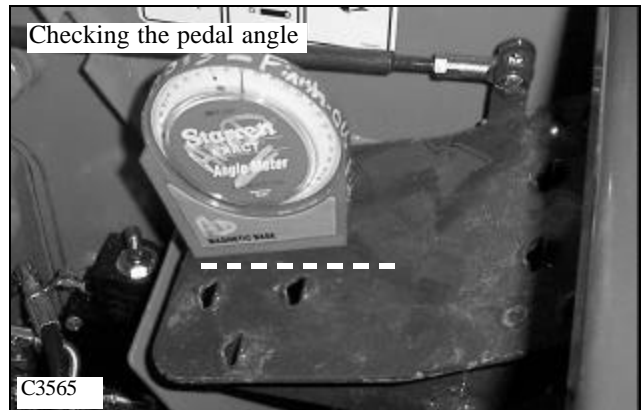

## FOOT PEDALS 4.2

### Foot Pedal Replacement

If the foot pedals or shaft need replacement due to damage or wear. Each pedal has its own shaft.

1 Raise the boom arms, engage the boom supports and shut off the engine.



#### WARNING

**Never work under the boom arms without the boom supports engaged.**

- 2 Remove the seat and hydrostatic shield.
- 3 Remove the bolt holding the linkage rod end to the pedal. (fig. C3563)
- 4 Remove bolts holding the center plate in place and remove the plate. (fig. C3565)
- 5 Remove the cap screw bolt retaining the foot pedal shaft to the side mount.
- 6 Remove and save any spacer washer if present.
- 7 Tip the inside end of the shaft up and remove the complete pedal and shaft assembly together. Keep count of the spacer washer used if present.
- 8 Replace worn parts as required. The foot pedals are equipped with bronze oillite bushings that are pressed into place and machined to size afterward. They are not serviceable separately. The complete pedal must be replaced.
- 9 Reinstall pedals in the reverse order. Total pedal movement side to side, end play, should not exceed 1/8".

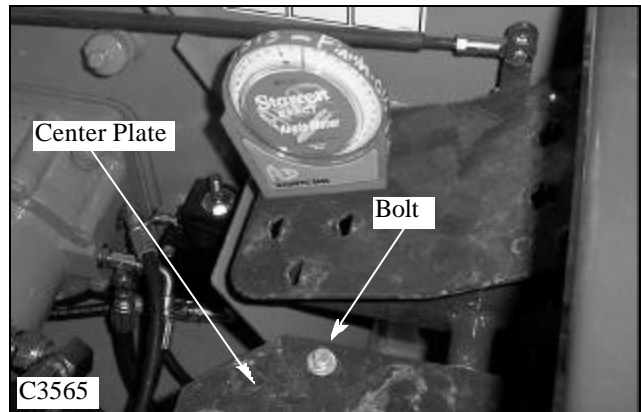
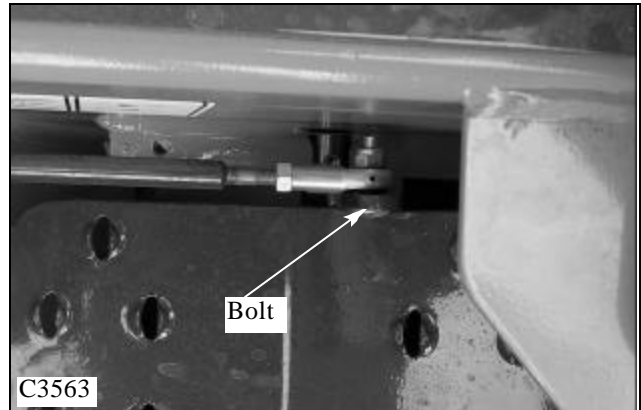

4

# HAND CONTROLS 4.3

175 Shown

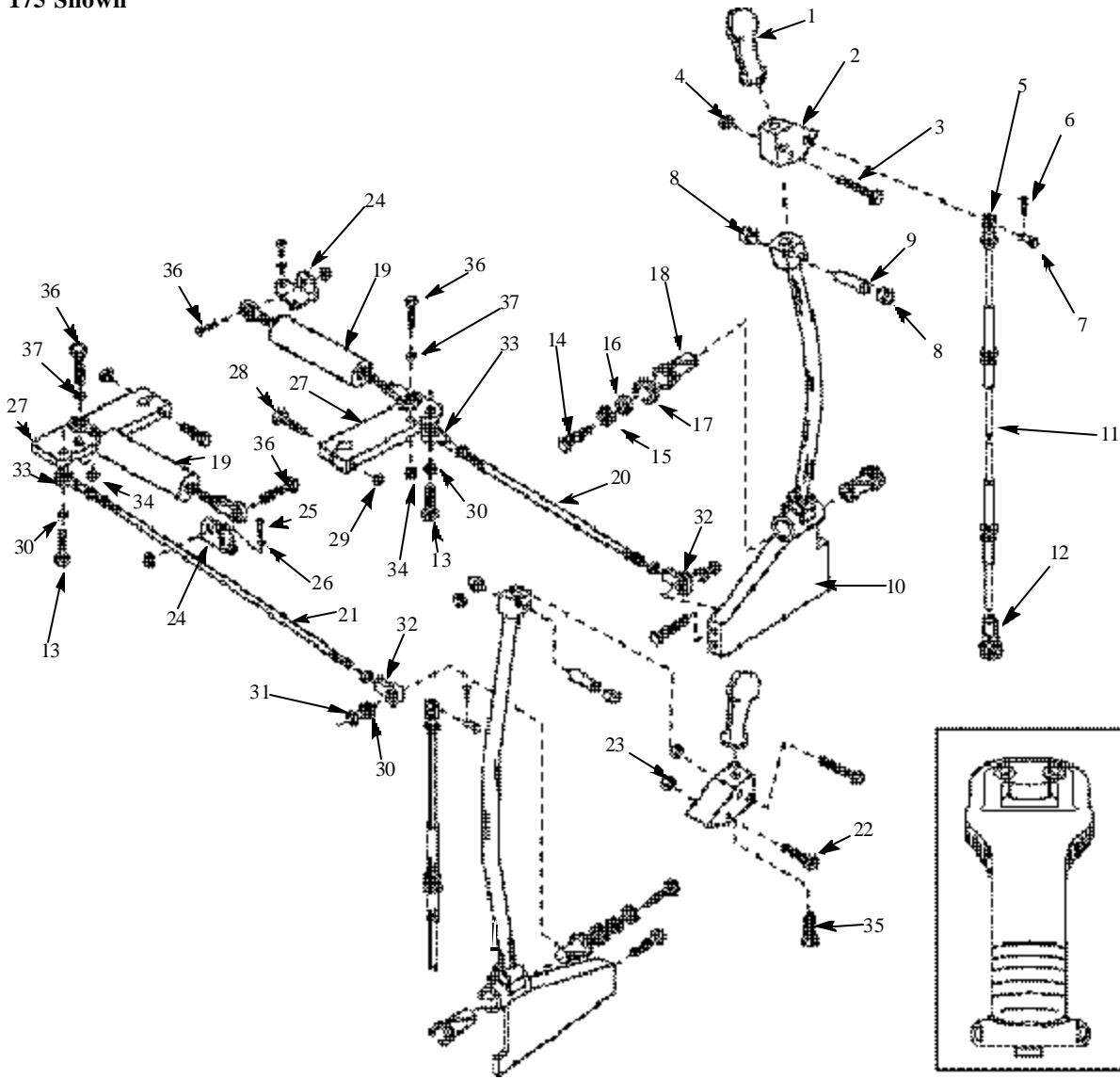

4

- |   |                            |                           |
|---|----------------------------|---------------------------|
| 1. Ergonomic Handle                             | 13. Hex Bolt               | 30. Lock Washer           |
| 2. Lever Base                                   | 14. Bolt                   | 31. Nylok Nut             |
| 3. Hex Bolt                                     | 15. Lock Washer            | 32. Female Rod End        |
| 4. Locking Jam Nut                              | 16. Flat Washer            | 33. Female Rod End        |
| 5. Clevis (Hand Control Loaders Only)           | 17. Fender Washer          | 34. Nylok Nut             |
| 6. Cotter Pin (Hand Control Loaders Only)       | 18. Flange Bushing         | 35. Ergonomic Handle Bolt |
| 7. Clevis Pin (Hand Control Loaders Only)       | 19. Hydroback              | 36. Hex Bolt              |
| 8. Flange Bushing                               | 20. Pintle Linkage Bar, LH | 37. Washer                |
| 9. Handle Spacer Tube                           | 21. Pintle Linkage Bar, RH |                           |
| 10. Control Lever                               | 22. Hex Bolt               |                           |
| 11. Push-Pull Cable (Hand Control Loaders Only) | 23. Nylok Hex Nut          |                           |
| 12. Rod End (Hand Control Loaders Only)         | 24. Hydroback Mount        |                           |
|   | 25. Bolt                   |                           |
|   | 26. Washer                 |                           |
|   | 27. Pintle Lever Ass'y     |                           |
|   | 28. Bolt                   |                           |
|   | 29. Nut                    |                           |

C3227

# HAND CONTROLS 4.3

## Cable Replacement

Check cable ends, eyelets or rod ends, and mounting pins for wear before removing the cable. Replace worn parts when replacing new cables. Cable ends should be inspected every 150 hours of operation.

1 Raise the boom arms, engage the boom supports and shut off the engine.



### WARNING

**Never work under the boom arms without the boom supports engaged.**

2 Remove the seat and hydrostatic shield. Unfasten control lever plates and disconnect the throttle. Slide boots over the handles so that the control levers are easily accessible. (fig. C3876 and fig. 3848)

3 Loosen jam nuts on the cable rod end and eyelet end. (fig. C3847 and fig. C3849)

4 Loosen the cable nuts on the control lever and the trans plate. (fig. C3847 and fig. C3848)

5 Remove cotter pins from lever base assembly end of the cable and remove the clevis pins. (fig. C3848)

6 Unbolt eyelet end of the cable, then remove the cable.

7 Remove the clevis and eyelet ends of the cable and reuse them if still serviceable.

8 Install the new cable in the reverse order above. There must be a minimum of 3/8" (6mm) of thread engagement into the cable rod end and eyelet ends.

**Note: After installation of a new cable, the control lever angle will need to be verified and adjusted if necessary. Refer to page 4-15.**

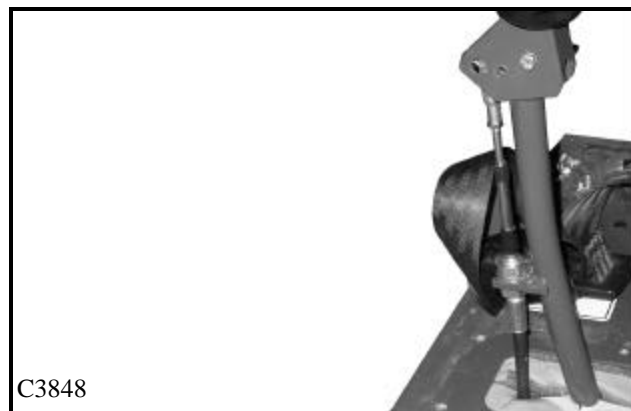
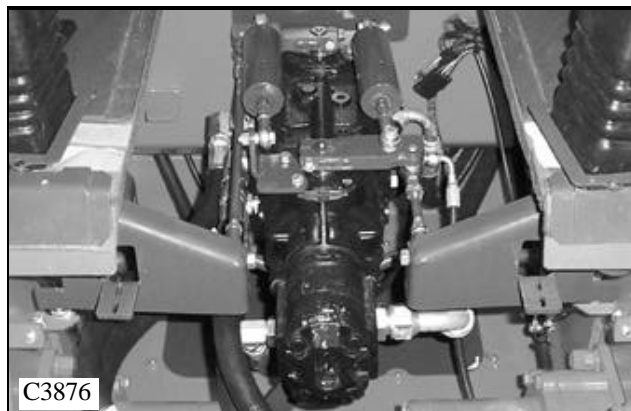

4

# HAND CONTROLS 4.3

## Angle Adjustment

After changing the control cable the control lever angle will need to be verified and / or adjusted to provide operator comfort and proper pedal travel clearance. Ensure the loader is parked on a level surface.

- 1 Make sure the cable ends are screwed onto the cable threads a minimum of 3/8" (6mm).
- 2 Place an angle finder on the top of the main tubing to find the base measurement. Take note of the reading.
- 3 Place the angle finder on the control lever as shown (fig. C3877). Note the reading. The correct angle is  $8^{\circ} + / - 1^{\circ}$ .
- 4 Adjust the angle by moving the cable nuts up or down on their mount. Adjustment may be made at the front and / or the rear of the cable. (fig. C3848 and fig. C3877)
- 5 Tighten all cable nuts and jam nuts on the cable ends. (fig. C3833 and fig. C3848)
- 6 Cycle the control levers to check for travel clearance.
- 7 Reconnect the throttle to the control lever plate. Fasten the control lever boots to the cab. Replace seat and hydrostatic shield. (fig. C3876)

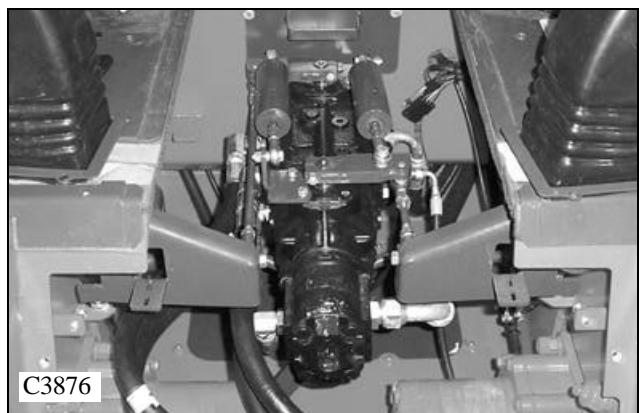
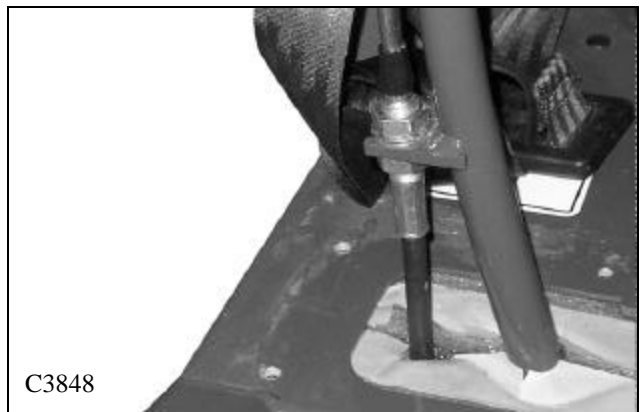

4

# HAND CONTROLS 4.3

## Control Lever Replacement

1 Raise the boom arms, engage the boom supports and shut off the engine.



### WARNING

**Never work under the boom arms without the boom supports engaged.**

- 2 Remove the seat and hydrostatic shield.
- 3 Remove control lever plates and boots. Disconnect throttle if necessary. (fig. C3876, C3832)
- 4 Remove cotter pins from the lever base ass'y and cable and remove the clevis pin. (fig. C3848)
- 5 Loosen the cable nuts and remove cable from mount on control lever.
- 6 Remove bolts from control rod.
- 7 Remove mounting bolts for control lever. (fig. C3847)
- 8 Remove control lever saving the plastic sleeve. Replace if necessary.
- 9 Replace all parts in reverse order. Cycle the control lever after installation to check for binding and travel clearance. Check control angles, wheel speed and tracking to ensure optimum performance.

**NOTE:** If the loader is equipped with optional electronic accessories operated by control handle mounted switches, the control handle switch wiring will need to be disconnected and transferred to the new steering lever.

If the control lever functions are sloppy due to excessive wearing of the swivel bushing, the swivel assembly may need replaced.

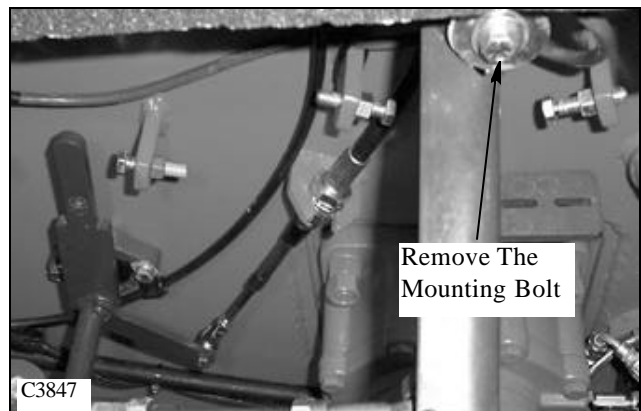
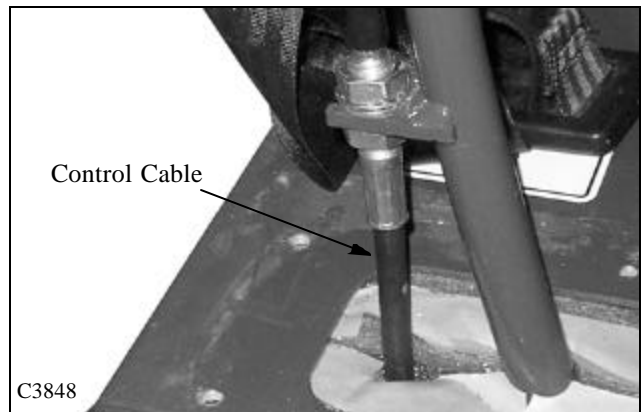
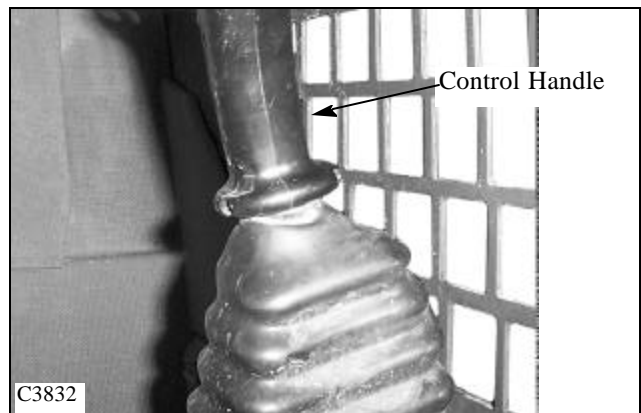
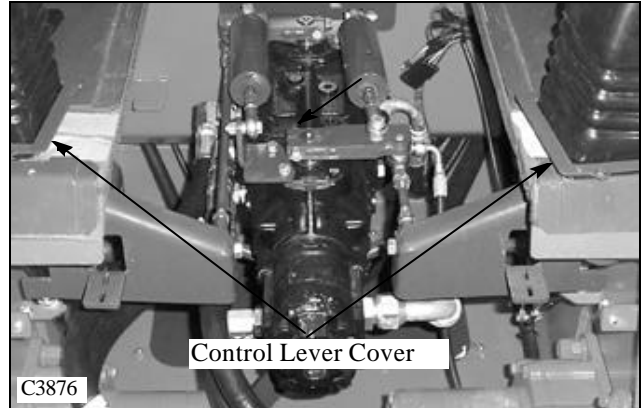

4

# THROTTLE 4.4

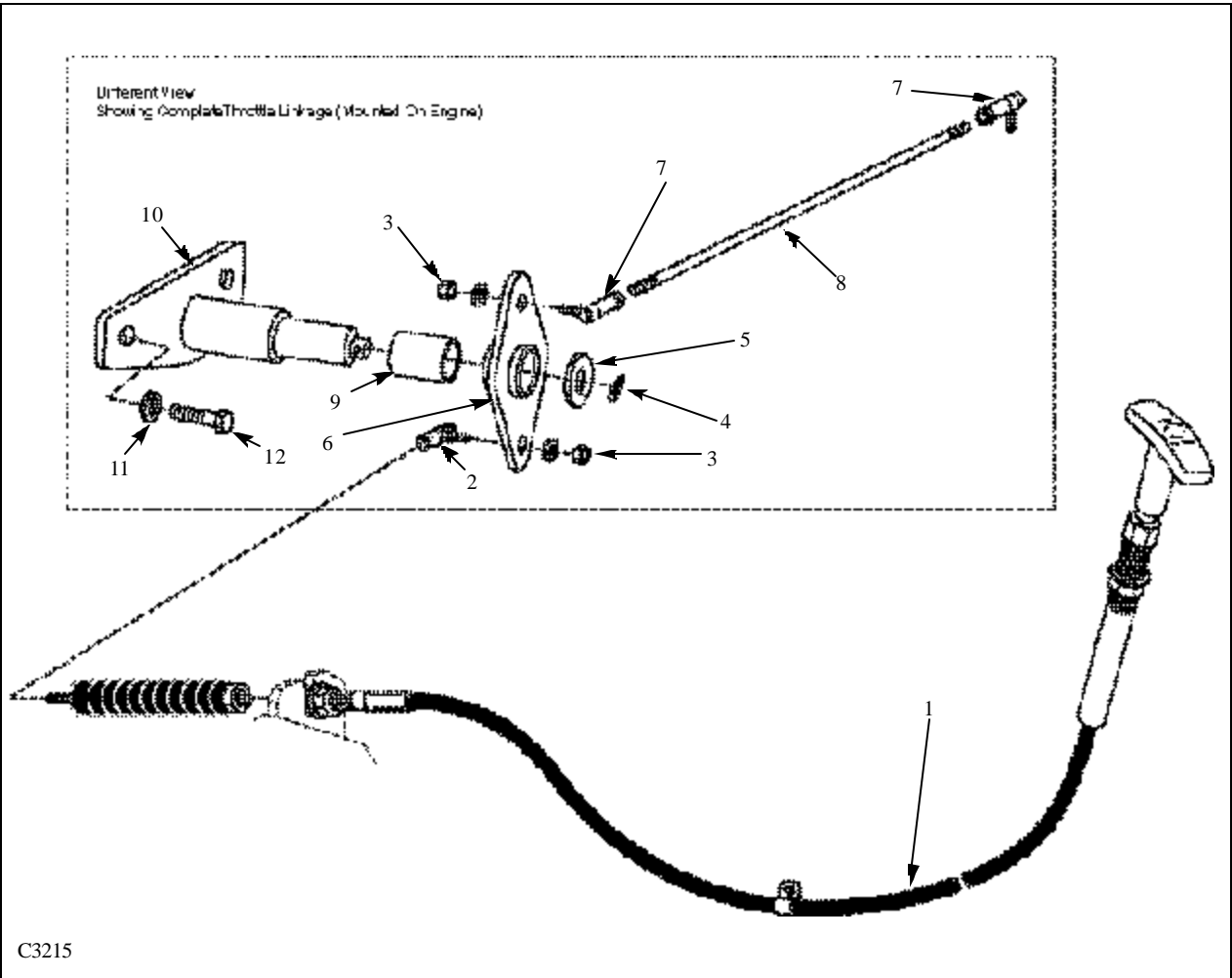

C3215

1. 56" Cable, Turn To Lock
2. Joint, Ball Socket
3. Nut, Hex
4. Pin, Spring
5. Washer, Flat
6. Linkage, Reverse Ass'y.
7. Joint, Ball Socket
8. Bar, Throttle Linkage
9. Bushing
10. Pivot, Throttle Ass'y
11. Washer, Lock
12. Bolt, Hex



# THROTTLE 4.4

## Throttle Cable Replacement

1 Raise the boom arms, engage the boom supports and shut off the engine.



### WARNING

Never work under the boom arms without the boom supports engaged.

2 Remove the seat and hydrostatic shield.(fig. C3557)

3 Remove the tee handle, nut and washer holding the assembly in place.

4 Open the rear door and unhook the throttle rod end from the throttle pivot assembly.(fig. C3567)

5 Pull the throttle cable out toward the front of the loader. (fig. C3570)

6 Remove the rod end left on the old throttle control cable and transfer it to the new control cable.

7 Replace the throttle control cable in the reverse order of above. Adjust the lock nut and tighten against the L.H. seat support on the underside of the deck.

8 Adjust the rod end on the throttle cable to obtain full travel.(fig. C3570)

NOTE: The throttle rod may need to be adjusted to ensure contact of the engine lever and the limiter bolts for highflow speed settings (up and down). (fig. C3567)

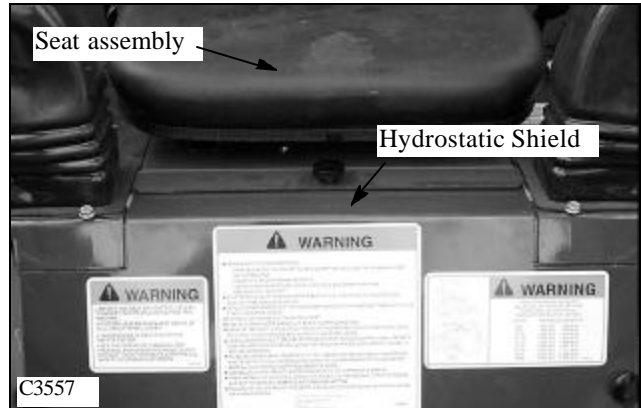

C3557

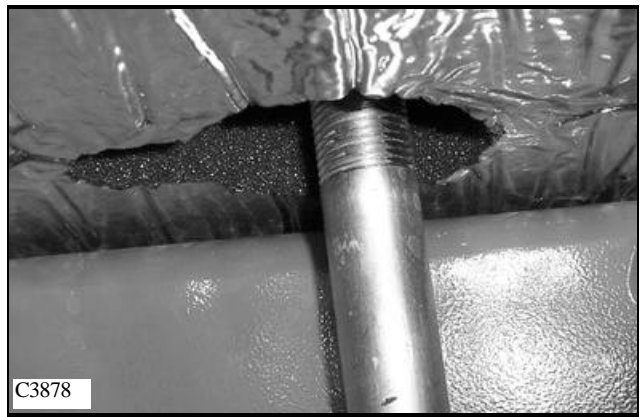

C3878

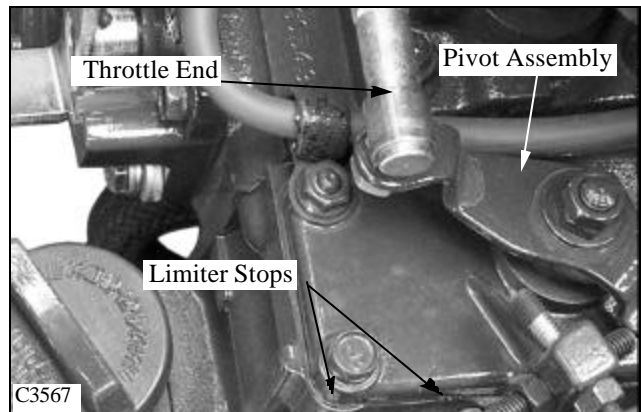

C3567

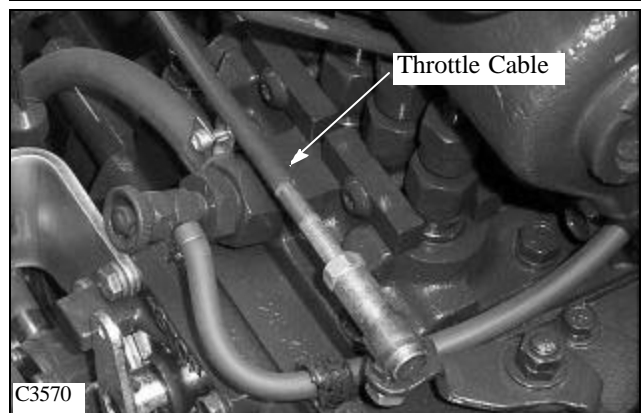

C3570

4

# RESTRAINT BAR 4.5

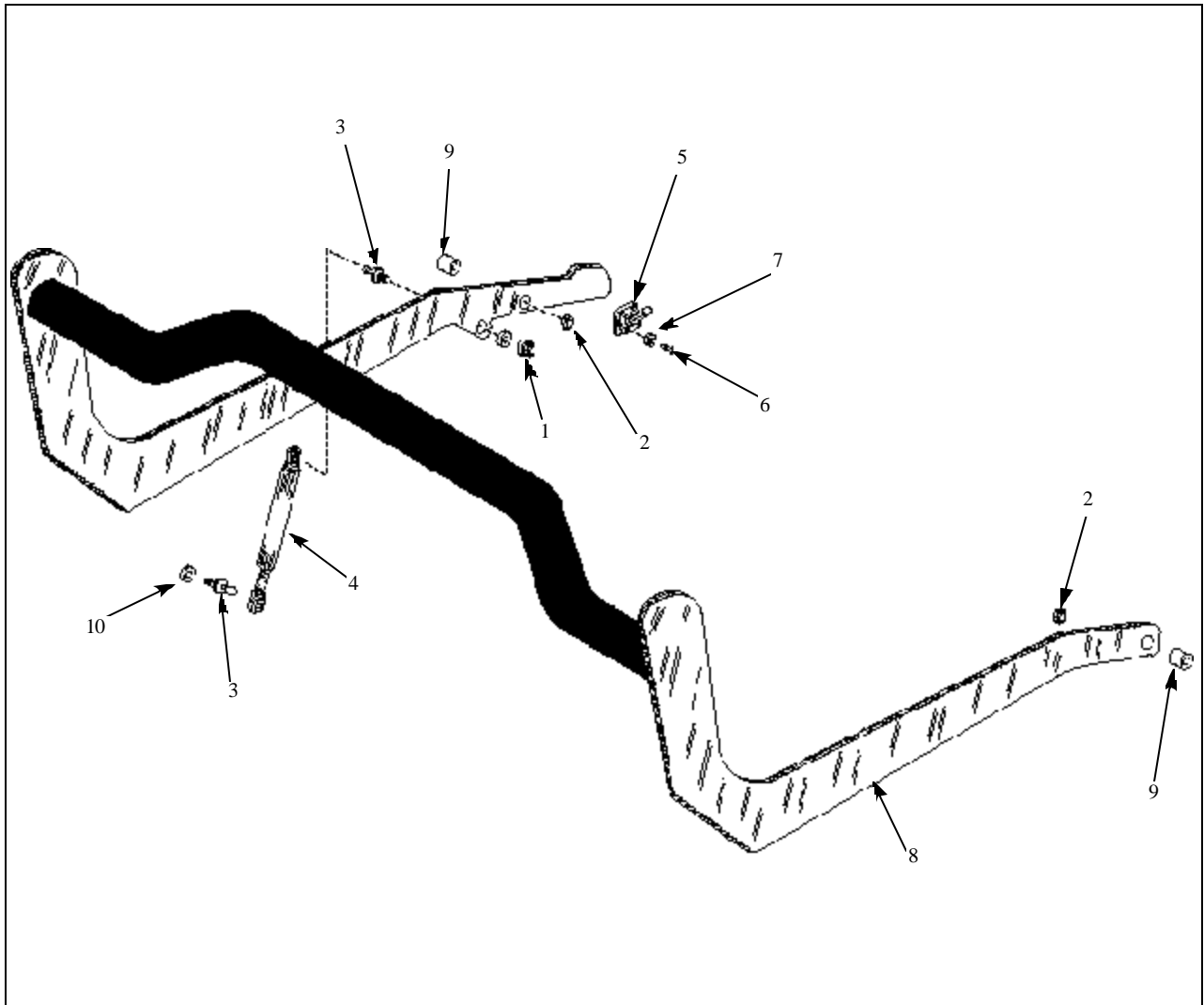

1. Nut, Jam
2. Nut, Nylok
3. Stud. Ball
4. Gas Spring
5. Switch, Dual
6. Screw, Self Tapping
7. Washer, Lock
8. Restraint Bar Ass'y
9. Spacer
10. Lockwasher

4

# RESTRAINT BAR 4.5

## Gas Spring Replacement

The restraint bar is held up, over head, by means of a gas assist type strut. (gas spring) (fig. C3571)

If the seal in the strut has deteriorated and failed, or the strut rod has been damaged, the restraint bar will not stay in the upright position due to gas pressure loss.

To replace the gas spring assembly:

- 1 Lower the liftarms and park the loader on a level surface. Shut off the engine.
- 2 Insert a small flat bladed screwdriver behind the spring clips (fig. C3572) on either end of the gas spring. Twist the screw driver while pulling out on the gas spring. Repeat for the opposite end.

- 3 Check the ball pivot mounts for wear or damage. (fig. C2043) Replace them if necessary.

- 4 The new gas spring is fully charged and is extended to full length when installed. (fig. C2044)
- 5 Push one end of the gas spring onto the ball pivot mount.
- 6 Raise the restraint bar and attach the opposite end.
- 7 Cycle the restraint bar to verify the new gas spring will hold the restraint bar in the upright position.

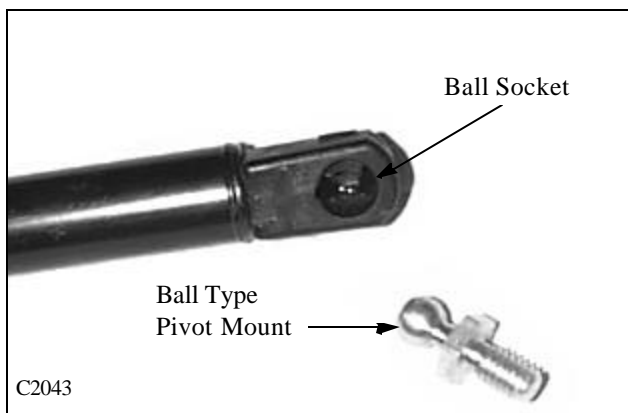
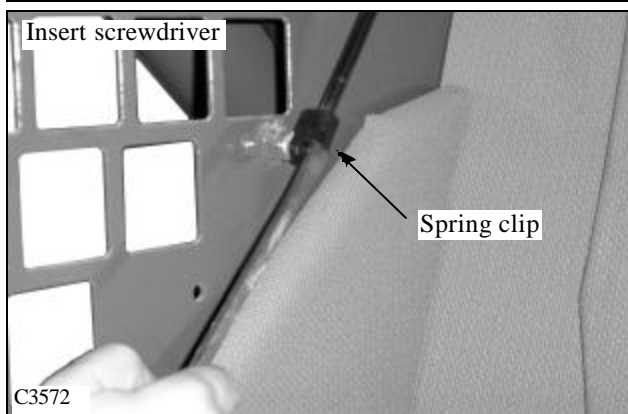
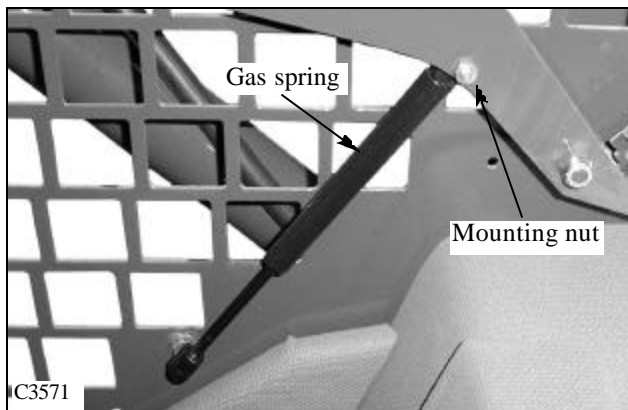

4

# RESTRAINT BAR 4.5

## Restraint Bar Replacement

- 1 Lower the liftarms and park the loader on a level surface. Shut off the engine.
- 2 Remove the nut from the upper gas spring pivot ball. (fig. C1105, C3573) Remove the mount and gas spring together allowing the restraint bar to lower.
- 3 Remove the 2 restraint bar mounting nuts. (fig. C1104) There is one on either side of the restraint bar.
- 4 Squeeze the restraint bar ends inward and remove each side from it's pivot / mounting bolt. Use caution, do not damage the safety switch located to the right rear of the restraint bar.
- 5 Replace the restraint bar in the reverse order. Use new lock nuts on the restraint bar mounts. Tighten to remove slack between the restraint bar and spacer bushings. Do not over tighten. The restraint bar should cycle freely up and down without binding.
- 6 Re- attach the upper ball pivot mount to the restraint bar. Cycle the restraint bar to check proper operation.
- 7 Check to make sure the safety switch is contacting the restraint bar, and functioning properly. This safety switch activates the parking brake when the engine is operating, the operator is seated with the seat belt fastened, and the restraint bar is in the raised position. Lower the restraint bar to release the parking brake.

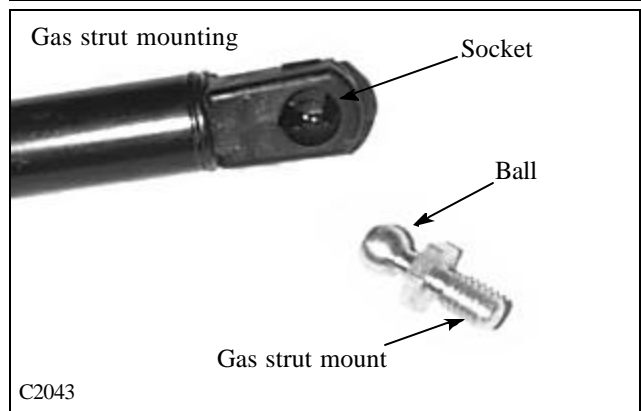
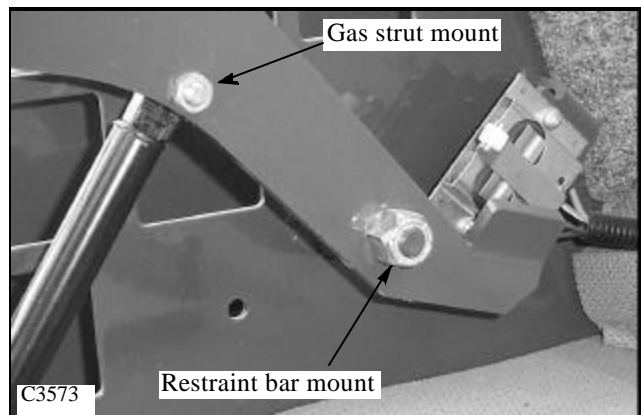
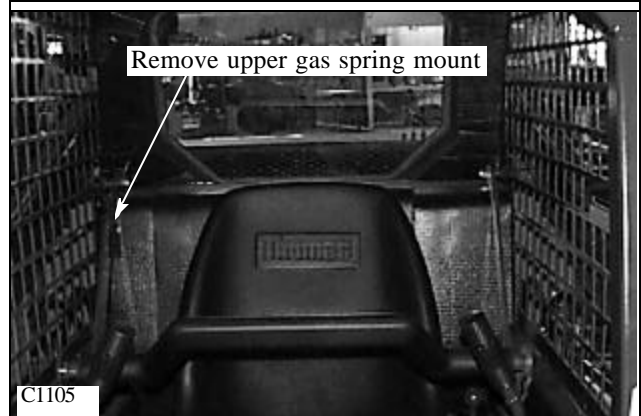
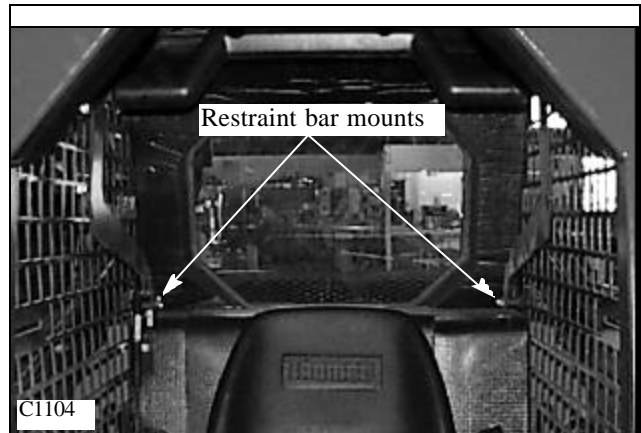

4

# PARKING BRAKE 4.6

## General Information

Each drive motor contains a set of clutch pack type friction discs that are spring loaded in the engaged position.

The parking brake is inter locked with various safety switches. (fig. C807, C3573, C3574, C3575) The parking brake will only release when the engine is operating, the operator is seated with the seat belt fastened and the restraint bar is in the lowered position.

The parking brake system requires 200 psi (13.78 bar) hydraulic pressure to release or separate the clutch packs in the drive motors. The hydraulic pressure is provided by the charge pressure relief valve in the hydrostatic tandem pump.

When the engine is operating and all safety switches are functioning and in the closed position, the hydraulic / electric solenoid brake valve (fig. C3575) will allow charge pressure to release the parking brake in the drive motors.

4

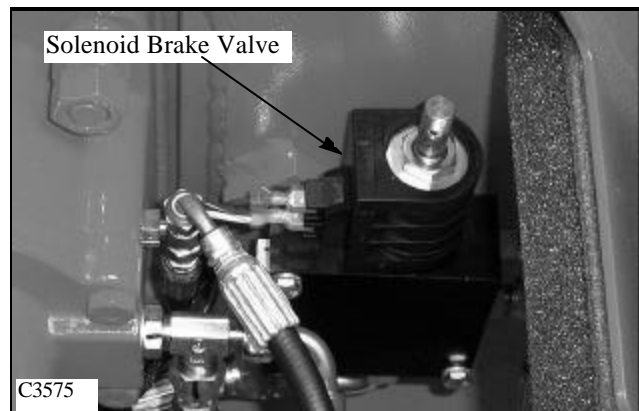
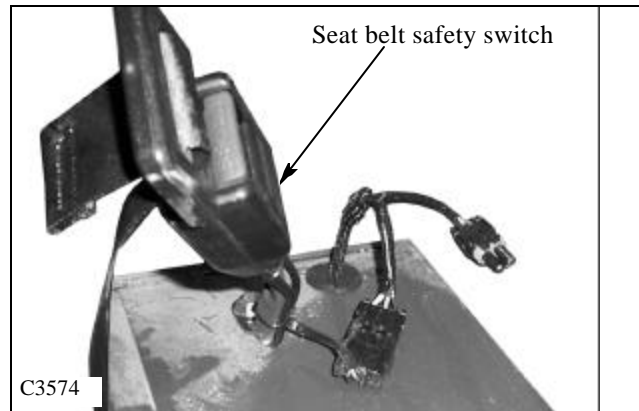
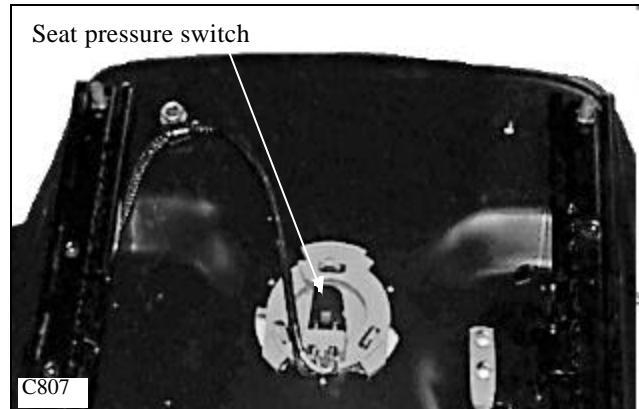

# TROUBLE SHOOTING 4.7

| Symptom  | Cause                               | Corrective Action      | Section  |
|--|-------------------------------------|------------------------|----------|
| Loader creeps, won't center                        | Neutral adjustment                  | Adjust linkage         | 4.1      |
|  | Worn, loose linkage                 | Replace, tighten parts | 4.1      |
|  | Binding, dragging parts             | Repair, replace        | 4.1      |
| Steering jerky                                     | Worn, loose linkage                 | Replace                | 4.1      |
|  | Binding linkage                     | Repair, replace        | 4.1      |
|  | Linkage adjustment                  | Adjust                 | 4.1      |
|  | Low charge pressure                 | Repair, replace        | 2        |
| Loader doesn't track straight                      | Limiter stops                       | Adjust                 | 4.1      |
|  | Binding linkage                     | Repair, replace        | 4.1      |
|  | Hydrostatic failure                 | Repair, replace        | 2        |
| Boom controls inoperative                          | Damaged cables, linkage             | Replace                | 4.2, 4.3 |
|  | Safety switch ( s )                 | Adjust, replace        | 5        |
|  | Bad electrical ground               | Repair                 | 5        |
|  | Blown fuse                          | Replace                | 5        |
|  | Valve lock malfunction              | Replace parts          | 1, 5     |
|  | Low hydraulic oil                   | Replenish              | 1        |
|  | No oil pressure                     | Make repairs           | 1        |
| Boom operation slow                                | Cable linkage                       | Replace, adjust        | 4.2, 4.3 |
|  | Aux. hydraulics engaged             | Disengage              |          |
|  | Engine RPM low                      | Adjust                 | 7        |
|  | Control valve relief                | Adjust, replace        | 1        |
|  | Cylinder seal, damage               | Repair, replace        | 1        |
| Boom controls stiff                                | Cable wear                          | Replace                | 4.2, 4.3 |
|  | Pivot wear                          | Replace parts          | 4.2, 4.3 |
|  | Control valve wear                  | Repair, replace        | 1        |
| Auxiliary hyd. inoperative (solenoid control type) | Blown fuse                          | Replace                | 5        |
|  | Switch ( s ) failure                | Replace                | 5        |
|  | Aux. valve malfunction              | Repair, replace        | 1        |
|  | Electrical short                    | Repair                 | 5        |
|  | Bad electrical ground               | Repair                 | 5        |
| Brake won't hold                                   | Service plunger on brake valve open | Inspect and service    | 2        |
|  | Brake disc wear or damage           | Repair, replace        | 2        |
| Brake won't release                                | Blown fuse                          | Replace                | 5        |
|  | Safety switch malfunction           | Adjust, replace        | 5        |
|  | Lack of hydrostatic charge pressure | Test, repair           | 2        |
|  | Brake valve failure                 | Repair, replace        | 2        |

