

MACHINE COMPONENTS

TRIM THIS EDGE

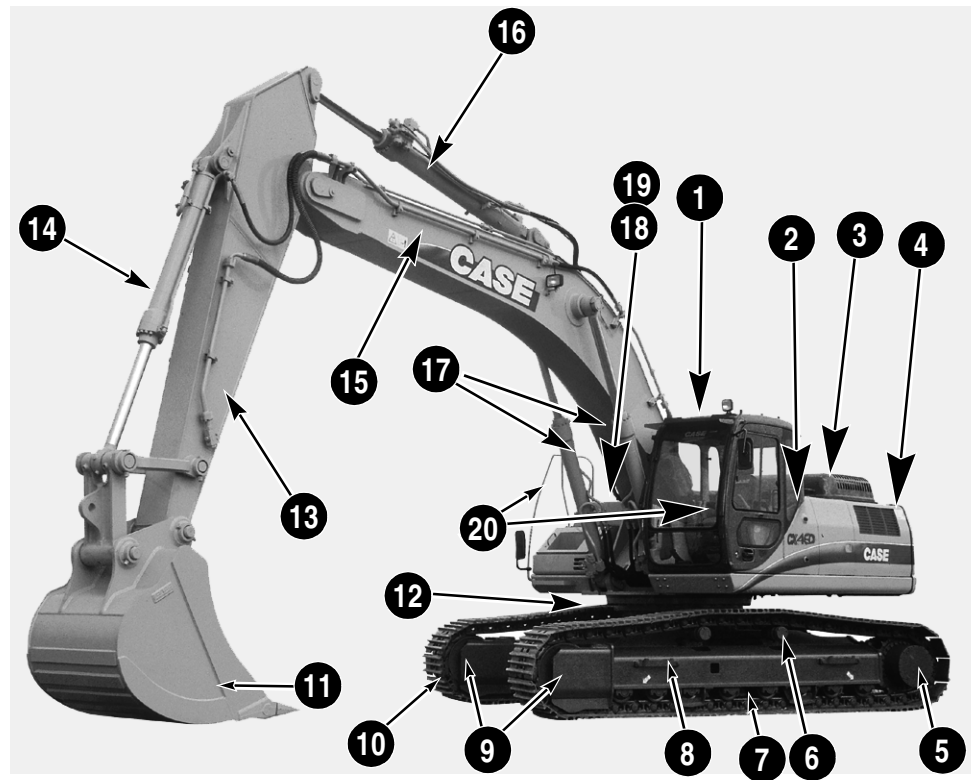

CD01K001

Key to main components

- | | |
|-------------------------------|-------------------------|
| 1. Cab/Operator's compartment | 12. Undercarriage |
| 2. Upperstructure | 13. Arm |
| 3. Engine compartment | 14. Bucket cylinder |
| 4. Counterweight | 15. Boom |
| 5. Travel reduction gears | 16. Arm cylinder |
| 6. Upper rollers | 17. Boom cylinders |
| 7. Lower rollers | 18. Hydraulic reservoir |
| 8. Steps | 19. Fuel tank |
| 9. Idler wheels | 20. Access handles |
| 10. Tracks | |
| 11. Bucket | |

6

TRIM THIS EDGE

LEFT PAGE

6-33740na

SAFETY/DECALS/HAND SIGNALS

SAFETY RULES

Most accidents involving machine operating and maintenance can be avoided by following basic safety rules and precautions. Read and understand all the safety messages in this manual, the safety manual and the safety signs on the machine before you operate or service the machine. See your dealer if you have any questions.

READ THIS MANUAL COMPLETELY and make sure you understand the controls. All equipment has a limit. Make sure you understand the speed, brakes, steering, stability and load characteristics of this machine before you start to operate.

DO NOT remove this manual or the safety manual from the machine. See your dealer for additional manuals. Also see the manual information on the inside of the rear cover of this manual.

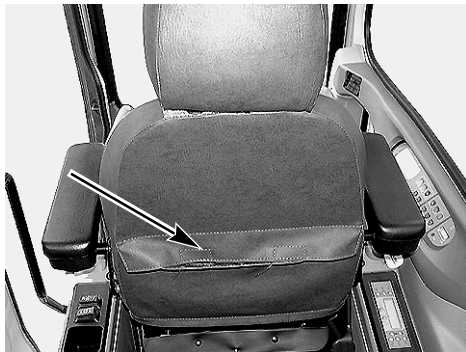

The safety information given in this manual does not replace safety codes, insurance needs, federal, state or local laws. Make sure that your machine has the correct equipment according to these rules or laws.

Additional safety messages are used in the text of the manual to show specific safety hazards.

TRIM THIS EDGE

BK99A006
OPERATOR'S MANUAL LOCATION AND STORAGE

IMPORTANT: *Safety messages in this section point out situations which can happen during the normal operation and maintenance of your machine. These safety messages also give possible ways of dealing with these conditions.*



WARNING: *This safety alert symbol indicates important safety messages in this manual. When you see this symbol, carefully read the message that follows and be alert to the possibility of death or serious injury.*

M171C

TRIM THIS EDGE

RIGHT PAGE (Section First Page)



Bur 6-33740na

⚠ PERSONAL SAFETY ⚠

Safety Decals on this machine use the words **Danger, Warning or Caution**, which are defined as follows:

- **DANGER:** Indicates an immediate hazardous situation which, if not avoided, will result in death or serious injury. The color associated with Danger is RED.
- **WARNING:** Indicates a potentially hazardous situation which, if not avoided will result in serious injury. The color associated with Warning is ORANGE.
- **CAUTION:** Indicates a potentially hazardous situation which, if not avoided, may result in minor or moderate injury. It may also be used to alert against unsafe practices. The color associated with Caution is YELLOW.

ISO two panel pictorial symbol decals are defined as follows:

- The first panel indicates the nature of the hazard.
- The second panel indicates the appropriate avoidance of the hazard.
- Background color is YELLOW.
- Prohibition symbols such as   and  if used are RED.

⚠ SAFETY AREA ⚠

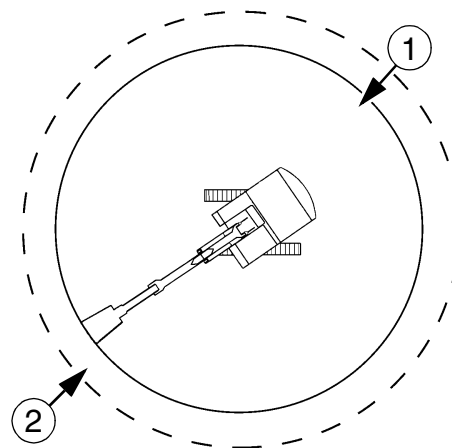

1. WORKING AREA
2. SAFETY AREA

CS97M019

- The safety area is the space necessary for the machine to operate at the maximum range of the tool and a full 360° swing plus 6 feet (2 metres).

TRIM THIS EDGE

LEFT PAGE

Bur 6-33740na

TRIM THIS EDGE

⚠️ UTILITY SAFETY ⚠️

Safety precaution **MUST** be followed when working near buried Utility Lines. During operation it is likely that you will be working around or near buried utility lines which may include, but are not limited to:

- Electrical Power Line
- Gas Line
- Water Line
- Communication Line - Telephone or Cable Television
- Sewer Line

Before beginning any trenching, drilling or other construction work it is your responsibility to be aware of all such utility lines buried in the area of your project and to avoid them.

ALWAYS have all local utility companies mark the location of their lines.

In U.S.A. and Canada call one of many "One Call System Directory" services. If you do not know the local number, call the national number (U.S.A. and Canada only): 1-888-258-0808.

Check with local authorities for laws, regulations and/or strict penalties requiring you to locate and avoid existing utilities.

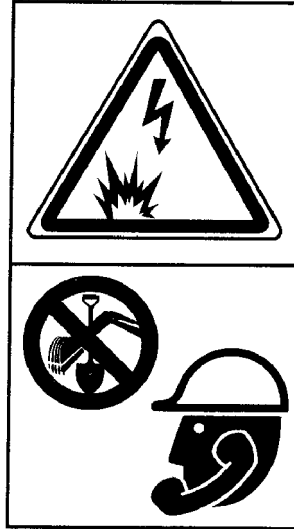

TRIM THIS EDGE

RH99G001
CALL ALL LOCAL UTILITY COMPANIES
BEFORE YOU TRENCH/DRILL

Know the utility color code (U.S.A. and Canada):

- Electric Red
- Gas, Oil or Petroleum Yellow
- Communication, Telephone, Television..... Orange
- Water Blue
- Sewer Green/Brown
- Proposed Excavation White
- Surveying Pink
- Reclaimed Water and Slurry Purple

After locating the utility lines, carefully dig a hole by hand and/or automatic vacuum equipment to the utility line to verify the location and depth of the line

TRIM THIS EDGE

RIGHT PAGE

Bur 6-33740na