

**ENGINE****Cooling System - Repair Instructions - X3****00 COOLANT, CHECKING COOLING SYSTEM****00 57 072 RETROFITTING SUPPLEMENTARY OIL COOLER (HIGH-SPEED SCOPE OPTION SA840) (N52K)**

*Necessary preliminary tasks:*

- Read out fault memory of DME control unit
- Switch off ignition
- Remove underbody protection, see **51 47 490 REMOVING AND INSTALLING / REPLACING FRONT UNDERBODY PROTECTION** .
- Replace front left wheel arch trim and replace dust lip
- Replace front left trim grille, see **51 11 185 REMOVING AND INSTALLING/REPLACING SIDE GRILLE IN BUMPER TRIM (FROM 09/2006)** .
- If necessary, replace left crashbox, see **51 11 770 REMOVING AND INSTALLING/REPLACING LEFT OR RIGHT DEFORMATION ELEMENT FOR FRONT BUMPER** .
- Remove air filter housing, see **13 71 000 REMOVING AND INSTALLING/REPLACING INTAKE FILTER HOUSING (N52K)** .
- Release servo reservoir, see **32 41 250 REMOVING AND INSTALLING/REPLACING FLUID RESERVOIR FOR POWER STEERING (M54, N46, N52)** .
- Remove alternator, see **12 31 020 REMOVING AND INSTALLING OR REPLACING ALTERNATOR (N52, N52K, N51, N53)** .
- Remove heater bulkhead, see **51 71 080 REMOVING AND INSTALLING/REPLACING HEATER BULKHEAD** .
- Drain coolant, see **17 00 005 Draining and adding coolant (N52K)**.
- Remove oil pressure switch , remove oil filter housing

Mount full-flow oil filter and connection housing for oil lines.

*Installation:*

Tightening torque: 11 42 3AZ, see **11 42 OIL FILTER ELEMENT WITH CONNECTIONS** .

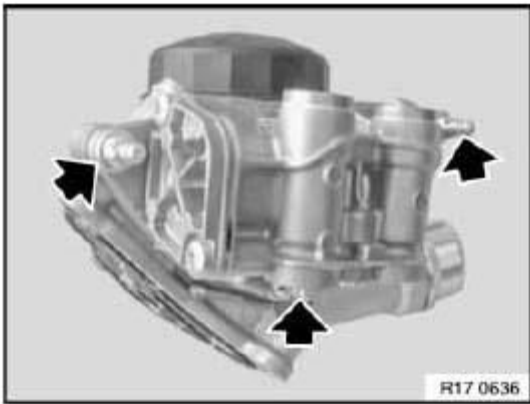

**Fig. 1: Locating Mount Full-Flow Oil Filter And Connection Housing For Oil Lines**  
Courtesy of BMW OF NORTH AMERICA, INC.

Mount oil filter housing on crankcase.

To facilitate mounting, remove coolant connection.

*Installation:*

Tightening torque: 11 42 2AZ, see **11 42 OIL FILTER ELEMENT WITH CONNECTIONS** .

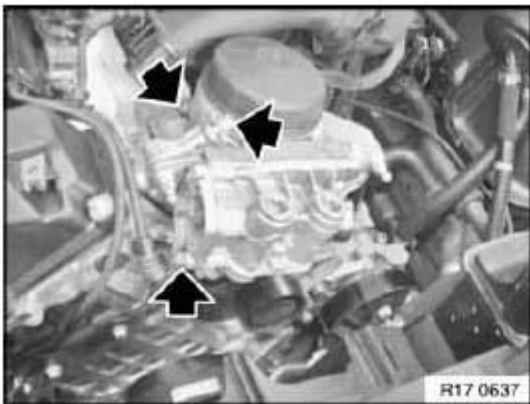

**Fig. 2: Locating Mount Oil Filter Housing On Crankcase**  
Courtesy of BMW OF NORTH AMERICA, INC.

Mount oil pressure switch on new filter housing.

*Installation:*

Tightening torque 12 61 2AZ.



**Fig. 3: Locating Mount Oil Pressure Switch On Filter Housing**  
Courtesy of BMW OF NORTH AMERICA, INC.

Mount sealing rings on oil supply and return lines.

Mount oil lines on filter housing (M8x28 screw).

*Installation:*

Lubricate sealing rings lightly with oil.

Tightening torque: 17 22 5AZ, see **17 22 OIL COOLER PIPES** .

Secure oil lines with pre-installed rubber grommet.

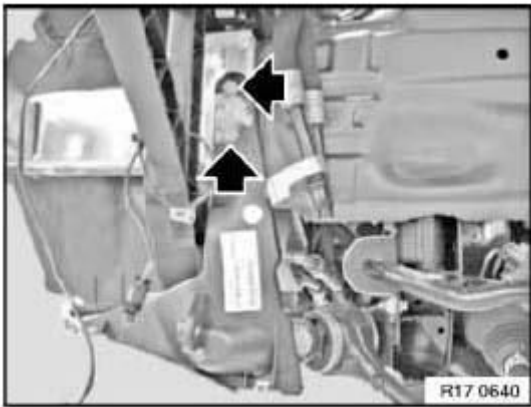

**Fig. 4: Locating Mount Sealing Rings On Oil Supply And Return Lines**  
Courtesy of BMW OF NORTH AMERICA, INC.

Remove underbody protection bracket.

Mount holding frame for engine oil cooler on crashbox.

There must be 2 press-in nuts for the radiator bracket on the crashbox, otherwise replace crashbox.

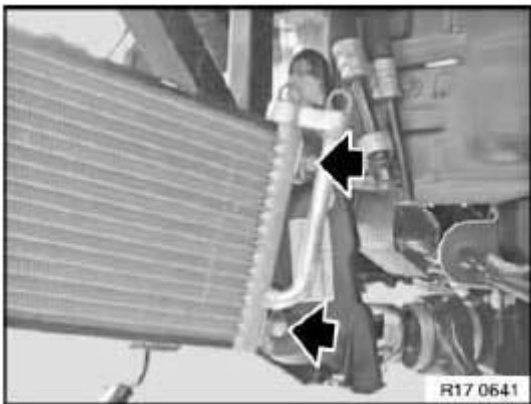

**Fig. 5: Locating Underbody Protection Bracket**  
Courtesy of BMW OF NORTH AMERICA, INC.

Mount engine oil cooler on oil cooler bracket (M8x35 screw).

*Installation:*

Tightening torque: 17 21 2AZ, see **17 21 ENGINE OIL COOLER** .

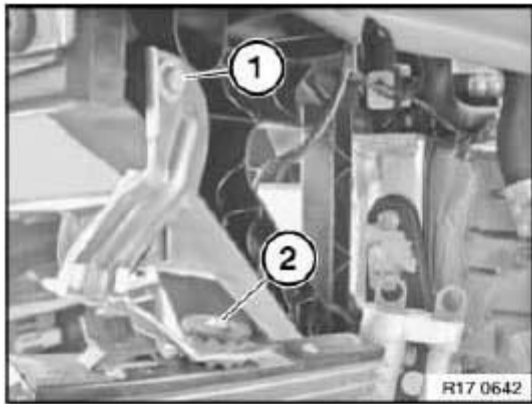

**Fig. 6: Locating Mount Engine Oil Cooler On Oil Cooler Bracket (M8X35 Screw)**  
Courtesy of BMW OF NORTH AMERICA, INC.

Mount wheel arch cooler bracket with vibration damper (rubber element).

*Installation:*

Tightening torque: 17 21 3AZ, see **17 21 ENGINE OIL COOLER** .



**Fig. 7: Mount Wheel Arch Cooler Bracket With Vibration Damper**  
Courtesy of BMW OF NORTH AMERICA, INC.

Mount sealing rings on oil supply and return lines.

Mount oil lines on engine oil cooler housing (M8x30 screw).

*Installation:*

Lubricate sealing rings lightly with oil.

Tightening torque: 17 22 5AZ, see **17 22 OIL COOLER PIPES** .

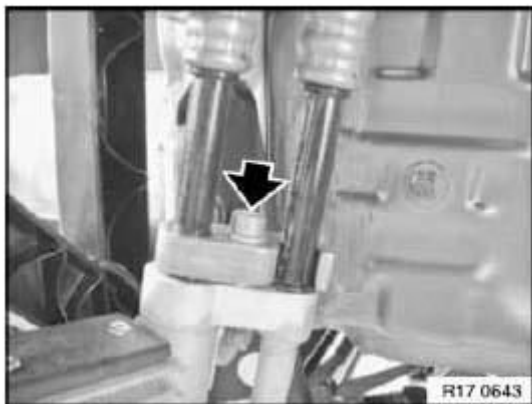

**Fig. 8: Locating Mount Sealing Rings On Oil Supply And Return Lines**  
Courtesy of BMW OF NORTH AMERICA, INC.

Mount wheel arch cover.

Mount dust lip.

Mount oil cooler protective grille in wheel arch cover.



**Fig. 9: Mount Wheel Arch Cover**  
Courtesy of BMW OF NORTH AMERICA, INC.

Mount air duct on engine oil cooler.

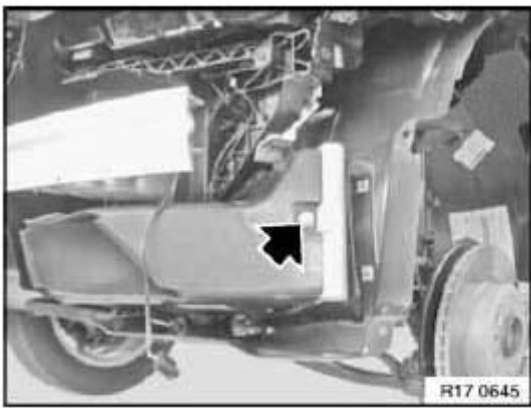

**Fig. 10: Locating Mount Air Duct On Engine Oil Cooler**  
Courtesy of BMW OF NORTH AMERICA, INC.

Replace closed cover in left bumper trim with grille panel.

